

Taphole Drilling Tools

—For Blast Furnances

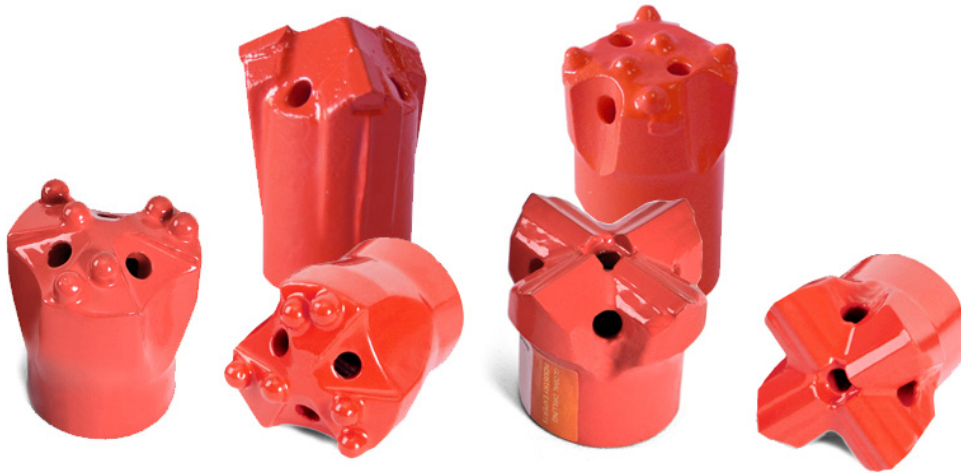

Taphole Drill Bit For Blast Furnaces



Carbide 3-blade Type

Description	Diameter		Part No.
	mm	in	
	45	1 3/4"	TC01-45
	48	1 7/8"	TC01-48
	51	2"	TC01-51
	54	2 1/8"	TC01-54
	57	2 1/4"	TC01-57
	64	2 1/2"	TC01-64
	76	3"	TC01-76
	89	3 1/2"	TC01-89
	102	4"	TC01-102

Carbide Cross Type

Description	Diameter		Part No.
	mm	in	
	35	1 3/8"	TC11-35
	38	1 1/2"	TC11-38
	45	1 3/4"	TC11-45
	48	1 7/8"	TC11-48
	51	2"	TC11-51
	54	2 1/8"	TC11-54
	57	2 1/4"	TC11-57
	64	2 1/2"	TC11-64
	76	3"	TC11-76
	89	3 1/2"	TC11-89
	102	4"	TC11-102

Carbide Thread Button Type

Description	Diameter		Part No.
	mm	in	
	45	1 3/4"	TC10-45
	48	1 7/8"	TC10-48
	51	2"	TC10-51
	54	2 1/8"	TC10-54
	57	2 1/4"	TC10-57
	64	2 1/2"	TC10-64
	76	3"	TC10-76
	89	3 1/2"	TC10-89
	102	4"	TC10-102

All-steel Cross Type

Description	Diameter		Part No.
	mm	in	
	35	1 3/8"	S11-35
	38	1 1/2"	S11-38
	41	1 5/8"	S11-41
	45	1 3/4"	S11-45
	48	1 7/8"	S11-48
	51	2"	S11-51
	54	2 1/8"	S11-54
	57	2 1/4"	S11-57
	64	2 1/2"	S11-64
	76	3"	S11-76
	89	3 1/2"	S11-89
	102	4"	S11-102

Taphole Drill Bit Part No. Rules

TC 01 - 45

TC	TC	Tungsten Carbide bit
	S	All Steel bit
01	01	3-blade type
	11	cross bit
	10	button bit
45	45	Diameter(mm)

Welding Button Bit



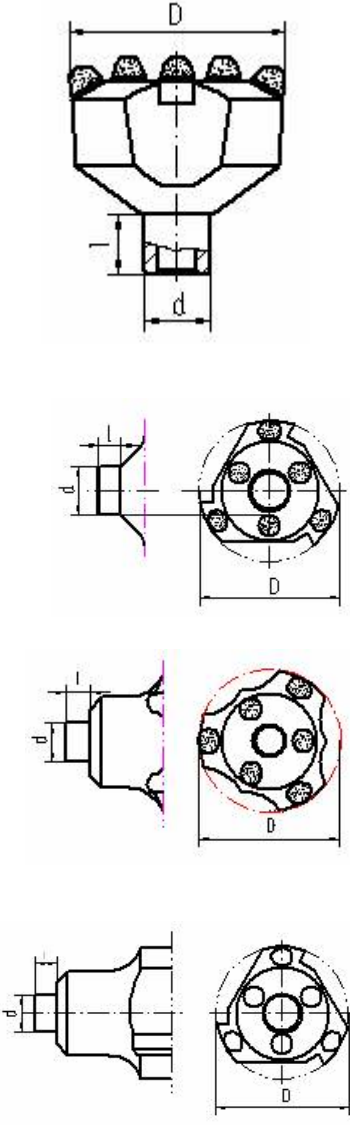

Description	Diameter	d	L	Carbides	Part No.
	mm	mm	mm		
	38	20	18	7	KWB3820-7A
	40	20	18	7	KWB4020-7A
	40	16.5	18	7	KWB4016-7A
	42	20	18	8	KWB4220-8A
	43	20	18	8	KWB4320-8A
	45	20	18	8	KWB4520-8A
	45	16.5	18	8	KWB4516-8A
	50	20	18	8	KWB5020-8A
	50	16.5	18	8	KWB5016-8A
	55	20	18	8	KWB5520-8A
	60	20	18	8	KWB6020-8A
	60	17	18	8	KWB6017-8A
	65	20	18	9	KWB6520-9A
	70	20	18	9	KWB7018-9A
	75	20	18	9	KWB7520-9A
	55	21	10	6	KWB5521-6B
	60	21	10	6	KWB6021-6B
	65	21	10	6	KWB6521-6B
	70	21	10	6	KWB7021-6B
	55	16	18	6	KWB5516-6A
60	16	18	6	KWB6016-6A	
65	16	18	6	KWB6516-6A	
70	16	18	6	KWB7016-6A	
55	16	10	6	KWB5516-6B	
60	16	10	6	KWB6016-6B	
65	16	10	6	KWB6516-6B	
70	16	10	6	KWB7016-6B	

We can provide this kind of products of different diameters. We also can make other kind of furnace taphole bits according to our clients' requirements.

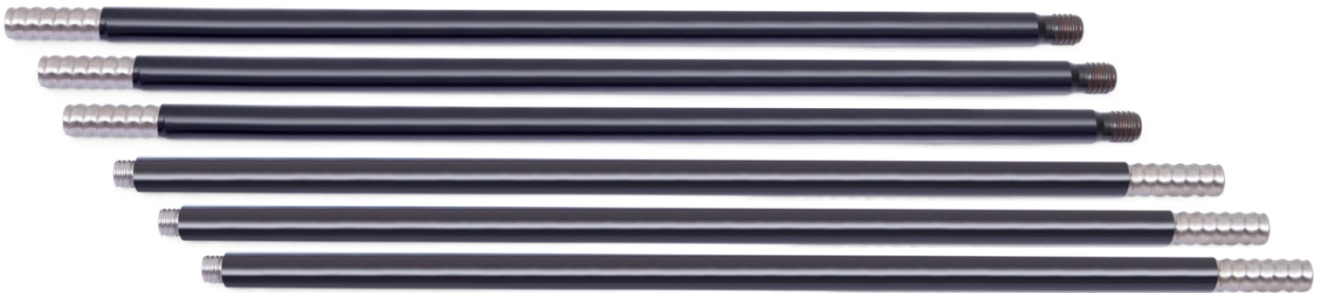

Taphole Drill Rod For Blast Furnaces



Single-Lug (Double-Lug) Threaded Drill Rod

Description	Length		Diameter		Part No.
	mm	in	mm	in	
	1830	6'	32	1 1/4"	KT32-18 H25L
	2435	8'	32	1 1/4"	KT32-24 H25L
	3050	10'	32	1 1/4"	KT32-30 H25L
	3660	12'	32	1 1/4"	KT32-36 H25L
	3830	12'6"	32	1 1/4"	KT32-38 H25L
	4300	14'1"	32	1 1/4"	KT32-43 H25L
	1830	6'	38	1 1/2"	KT38-18 D30L
	2435	8'	38	1 1/2"	KT38-24 D30L
	3050	10'	38	1 1/2"	KT38-30 D30L
	3660	12'	38	1 1/2"	KT38-36 D30L
	3830	12'6"	38	1 1/2"	KT38-38D30L
	4300	14'1"	38	1 1/2"	KT38-43 D30L



Single-Lug(Double-Lug) Welding Drill Rod

Description	Length		Diameter		Part No.
	mm	in	mm	in	
	3500	11'6"	32	1 1/4"	KW32-35L
	4270	14'	32	1 1/4"	KW32-42L
	4420	14'6"	32	1 1/4"	KW32-44L
	5000	16'4"	32	1 1/4"	KW32-50L
	5400	17'7"	32	1 1/4"	KW32-54L
	6000	19'8"	32	1 1/4"	KW32-60L
	3500	11'6"	38	1 1/2"	KW38-35L
	4270	14'	38	1 1/2"	KW38-42L
	4420	14'6"	38	1 1/2"	KW38-44L
	5000	16'4"	38	1 1/2"	KW38-50L
	5400	17'7"	38	1 1/2"	KW38-54L
	6000	19'8"	38	1 1/2"	KW38-60L

Extension Drill Rod

Description	Length		Diameter		Part No.
	mm	in	mm	in	
	1830	6'	32	1 1/4"	KE32-18R32/H25
	2435	8'	32	1 1/4"	KE32-24R32/H25
	3050	10'	32	1 1/4"	KE32-30R32/H25
	3660	12'	32	1 1/4"	KE32-36R32/H25
	3830	12'6"	32	1 1/4"	KE32-38R32/H25
	4300	14'1"	32	1 1/4"	KE32-43R32/H25
	1830	6'	38	1 1/2"	KE38-18R38/R38 (KE38-18R38 / D30)
	2435	8'	38	1 1/2"	KE38-24R38/R38 (KE38-24R38 / D30)
	3050	10'	38	1 1/2"	KE38-30R38/R38 (KE38-30R38 / D30)
	3660	12'	38	1 1/2"	KE38-36R38/R38 (KE38-36R38 / D30)
	3830	12'6"	38	1 1/2"	KE38-38R38/R38 (KE38-38R38 / D30)
	4300	14'1"	38	1 1/2"	KE38-43R38/R38 (KE38-43R38 / D30)

Semi-finished Materials

Description	Length		Part No.
	mm	in	
	32	1 1/4"	Hollow Drill Steel
	38	1 1/2"	
	32	1 1/4"	Seamless Steel Pipe
	38	1 1/2"	

Welding Button Bit Part No. Rules

K WB 38 20 -7 A

K	MAXDRILL	
WB	Welding Button Bit	
38	Diameter	38mm-70mm
20	d	16.5mm-21mm
7	Carbide Number	6-9
A	A	L=18
	B	L=10

Tap hole Drill Rod Part No. Rules

K T 32 -18 R32/H25L

K	MAXDRILL	
T	T	Threaded Drill Rod
	W	Welding Drill Rod
	E	Extension Drill Rod
	C	Coupling Sleeve
32	Diameter	
18	Length	1830mm-4300mm
R32	Thread	
H25		
L	Lug	